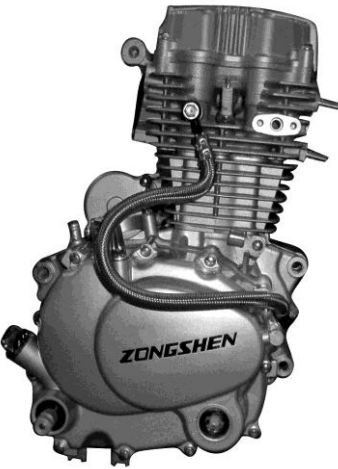

ZS150-6摩托车零部件图册

(1505-227/1508-196批, 秘鲁)

www.seacubemoto.com

发动机 ENGINE		Revision Number Page:2			
	NO.	PART CODE	CHINESE DESCRIPTION	ENGLISH DESCRIPTION	QTY
	1	10001-J170-00B577	发动机 (CG150D-C, 欧 II)	ENGINE	1
	1	10001-J170-00B401	发动机 (CG150D-C, 欧 II)	ENGINE	1
	2				
	3				
	4				
	5				
	6				
	7				
	8				
	9				
	10				
	11				
	12				
	13				
	14				
	15				
	16				
	17				
	18				
19					

www.seacubemoto.com

前照灯HEAD LIGHT		Revision Number Page:3			
	NO.	PART CODE	CHINESE DESCRIPTION	ENGLISH DESCRIPTION	QTY
	1	63501-1126-0000A5	ZS125-2前照灯灯壳(透明红+亚黑)	Headlamp case(red+Frosted black)	1
	1	63501-1126-0000V9	ZS125-2前照灯灯壳(油绿+亚黑)	Headlamp case(green+Frosted black)	1
	1	63501-1126-00002R	ZS125-2前照灯灯壳(老挝灰+亚黑)	Headlamp case(grey+Frosted black)	1
	1	63501-1126-0000D6	ZS125-2前照灯灯壳(浅紫深蓝+亚黑)	Headlamp case(light purple dark blue+Frosted black)	1
	1	63501-1126-0000A2	ZS125-2前照灯灯壳(珍珠黑+亚黑)	Headlamp case(pearl black+Frosted black)	1
	2	63503-1126-0200	ZS125-2(I)前照灯灯壳胶条	Strip,headlamp shade	1
	3	63504-1126-000066	ZS125-2前照灯灯壳背板(亚黑)	Backboard	1
	4	86100-1126-C600	ZS125-2(I)前照灯(水晶、防紫外线)	Headlamp	1
	5	86160-0000-0100	前照灯灯泡12V35/35W	Bulb 12v35/35w	1
	6	86112-0000-0000	前位置灯灯泡12V5W	Bulb 12v5w	1
	7	B057830008002070C	螺栓M8x20	Bolt M8x20	2
	8	B0009300080000K0C	GB/T93弹圈φ8(彩锌)	Spring washer 8	2
	9	B0009701080000K0C	平垫圈8	Washer 8	2
	10	B0084500030010X0L	GB/T845自攻螺钉ST3x10(军绿450HV)	Screw st3x10	4
	11	86111-1126-0800	前照灯线束	Wire, front lamp	1
	12	8610Z-1126-C600	前照灯反光碗及灯罩组合	Reflector and lampshade assembly	1
	13				
	14				
	15				
	16				
17					
18					
19					
20					

转向灯TURNING LAMP		Revision Number Page:4				
	NO.	PART CODE	CHINESE DESCRIPTION	ENGLISH DESCRIPTION	QTY	
	1	86320-I126-C500	ZS125-2转向灯(白色水晶灯、防紫外线)	Turning lamp	4	
	2	86301-I126-0000	ZS125-2转向灯胶套	Collar	4	
	3	8630H-I126-0400	内衬	Inner	4	
	4	86340-0000-0300	转向灯灯泡12V10W	Bulb 12v10w	4	
	5	B0084500030010X0L	GB/T845自攻螺钉ST3x10(军绿450HV)	Screw st3x10	8	
	6	B057830005002070C	GB/T5783螺栓M5x20(彩锌8.8级)	Bolt M5x20	8	
	7	8630M-I126-0400	抱箍	Hoop	4	
	8	86304-I126-C500	转向灯罩	lampshde, turning lamp	4	
	9					
	10					
	11					
	12					
	13					
	14					
	15					
	16					
	17					
	18					
	19					
	20					

仪表METER					Revision Number Page:5
	NO.	PART CODE	CHINESE DESCRIPTION	ENGLISH DESCRIPTION	QTY
	1	87100-I126-C140	ZS125-2仪表总成(无汉字、防紫外线)	Meter assy	1
	2	87123-0000-0000	仪表灯泡12V3W	Bulb 12V3W	7
	3	B0009601060000K0C	大平垫6	Washer 6	2
	4	B061700006000060C	螺母M6	Nut M6	2
	5	71201-I126-0200	ZS125-2轴承上挡圈(锥形)	Upper circlip,bearing	1
	6	87133-I126-2300	仪表线束	meter cable	1
	7	71203-I126-0200	ZS125-2轴承上座圈(锥形)	Upper race,bearing	1
	8	71204-I126-0200	ZS125-2轴承下座圈(锥形)	Lower race,bearing	1
	9	71204-I126-0200	ZS125-2轴承下挡圈(锥形)	Lower circlip,bearing	1
	10				
	11				
	12				
	13				
	14				
	15				
	16				
	17				
	18				
	19				
	20				

www.seacubemoto.com

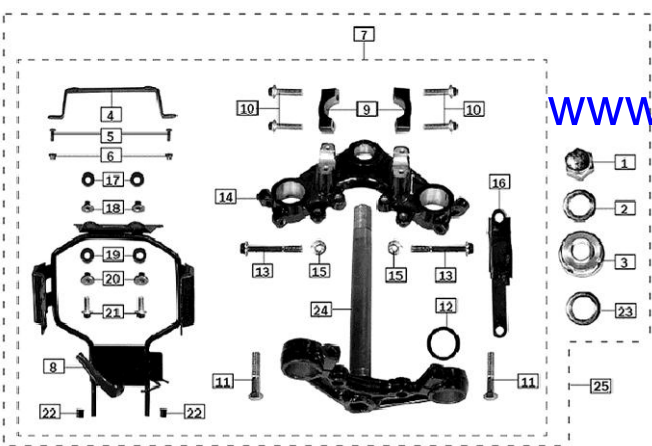

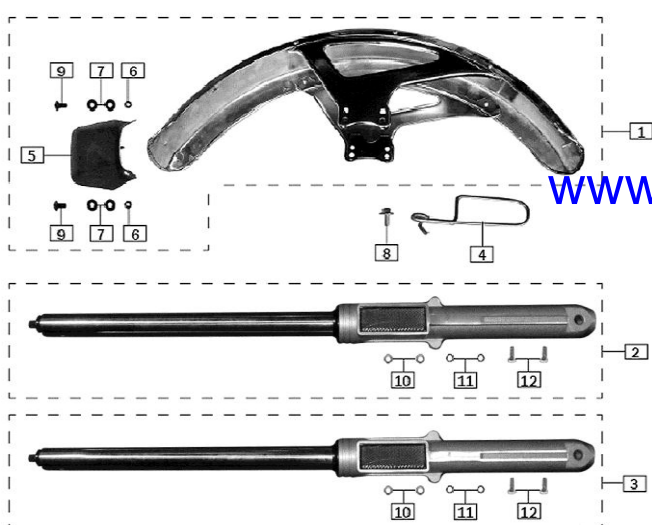

方向柱STEERING STEM				Revision Number Page:6	
	NO.	PART CODE	CHINESE DESCRIPTION	ENGLISH DESCRIPTION	QTY
	1	71104-I126-00000G	ZS125-2(I)方向柱盖型螺母(镀铬)	Cap nut	1
	2	71191-I126-00000G	ZS125-2(I)方向柱小平垫(镀铬)	Washer	1
	3	71105-I126-00000C	ZS125-2(I)方向柱调节螺母(彩锌)	Lock nut	1
	4	38250-I126-000065	前装饰罩支架	Fixing bracket,decoration cover	1
	5	B008180004001050L	螺钉M4x10	Screw M4x10	2
	6	91302-0040-11010L	翻边垫	Fanged washer	2
	7	7110A-I126-C00065	ZS125-2(I)方向柱组件(拆分状态,I126-090065,珍珠黑)	Steering stem Groupware	1
	8	86103-I126-050065	前照灯支架	Bracket,front lamp	1
	9	7111A-I126-090065	方向柱卡子	Clamp,steering bar	2
	10	B166740106003070C	螺栓M6x30	Bolt M6x30	4
	11	B057820008004070C	螺栓M8x40	Bolt M8x40	2
	12	71124-I126-0900	方向柱防尘圈	Dustproof ring,steering post	2
	13	B166740107005470G	螺栓M7x54	Bolt M7x54	2
	14	71101-I126-090065	上连接板	Upper connecting plate	1
	15	B061770107000060G	螺母M7	Nut M7	2
	16	38250-I126-010065	前装饰罩支架	Fixing bracket,decoration cover	1
	17	6222A-I126-0100	工字形胶垫 $\phi 8.6 \times \phi 14 \times \phi 20-7+3+4$	Rubber pad $\phi 8.6 \times \phi 14 \times \phi 20-7+3+4$	2
	18	91302-0060-20090C	翻边垫	Fanged washer	2
	19	6222A-I126-0000	工字形胶垫 $\phi 8.6 \times \phi 14 \times \phi 22-5.5+3+5.5$	Rubber pad $\phi 8.6 \times \phi 14 \times \phi 22-5.5+3+5.5$	2
	20	91302-0065-22120C	翻边垫	Fanged washer	2
	21	B166740106002570C	螺栓M6x25	Bolt M6x25	2
	22	87102-I126-0000	仪表支架减震垫	Damping pad, meter bracket	2
	23	71192-I126-00000C	ZS125-2(I)方向柱大平垫(彩锌)	Washer	1
	24	71121-I126-000065	方向柱立管	Standing tube, steering post	1
	25	71100-I126-090065	ZS125-2(I)方向柱总成(珍珠黑)	Steering stem comp	1

前减震器/前挡泥板 FRONT SHOCK ABSORBER / FRONT FENDER

			Revision Number Page:7				
			NO.	PART CODE	CHINESE DESCRIPTION	ENGLISH DESCRIPTION	QTY
			1	63104-I126-0300G	ZS125-2(1)前挡泥板(新款,无牌照支架,护线环孔φ6,镀铬)	Front fender	1
			2	34100-J170-C20071	ZS150-6(V)左前减震器(双后减、鼓刹、打气减震、银白)	Front shock absorber,left	1
			3	34200-J170-C20071	ZS150-6(V)右前减震器(双后减、鼓刹、打气减震、银白)	Front shock absorber,right	1
			4	63111-G128-0000C	ZS100-8护线环(彩锌)	Ring,guard wire	1
			5	63127-I126-0400	尾翘	Rear cover	1
			6	B0617000050000600	六角螺母M5	Nut m5	2
			7	B0009601060000K00	平垫圈 6	Washer 6	4
			8	B166740-06002070C	GR-T16674-1螺栓M6×20(彩锌8.8级)	Bolt M6×20	1
			9	B0081800050012200	十字槽盘头螺栓螺钉M5	Screw m5	2
			10	B0084800060000K0C	平垫圈 6	Washer 6	4
			11	B0009300060000X0C	弹簧垫圈 6	Spring washer 6	4
			12	B057830006001470C	螺栓M6×14	Bolt m6×14	4
			13				
			14				
			15				
			16				
			17				
			18				
			19				
			20				

手把/后视镜GRIP/BACK VIEW MIRROR

		Revision Number Page:8				
		NO.	PART CODE	CHINESE DESCRIPTION	ENGLISH DESCRIPTION	QTY
		1	69110-1126-04000G	ZS125-2^(I)左后视镜(激光刻字)	Left rear view mirror	1
		2	72100-1126-0500	ZS125-2方向把管(电启动、不锈钢)	Steering pipe	1
		3	72020-1377-000065	ZS125-24右手把胶套组合(黑色)	Comp,right grip	1
		4	72030-1126-010065	ZS125-2装饰头组件(金属烤漆)	Groupware,decoration head	2
		5	72209-1126-020066	ZS125-2(I)离合手柄(三统一、亚黑)	Clutch lever	1
		6	72208-1126-0600	风门手柄	Handlebar,choke	1
		7	69120-1126-04000G	ZS125-2^(I)右后视镜(激光刻字)	Right rear view mirror	1
		8	72309-1126-020066	ZS125-2^(I)前制动手柄(三统一亚黑)	Front brake lever	1
		9	72010-1377-000065	ZS125-24左手把胶套(黑色)	Left grip	1
		10	72201-1126-0300	ZS125-2(I)左开关总成(三统一)	Assembly,left switch	1
		11	72301-1126-0300	ZS125-2(I)右开关总成(三统一)	Assembly,right switch	1
12						
13						
14						
15						
16						
17						
18						
19						
20						

软轴/拉索SOFT ALXE/CABLE		Revision Number Page:9			
	NO.	PART CODE	CHINESE DESCRIPTION	ENGLISH DESCRIPTION	QTY
    	1	72700-I126-05000L	ZS125-2(I)风门拉索(三统一、军绿)	Cable,choke	1
	2	72400-I126-05000L	ZS125-2(I)油门拉索(三统一、军绿)	Cable throttle	1
	3	72500-J170-C0000L	ZS150-6(IV)前制动拉索(管长1090,露长90、军绿)	Cable front brake	1
	4	72600-I126-21000L	ZS125-2离合拉索(CG, 露长90mm、军绿)	Cable clutch	1
	5	87300-I126-00000L	ZS125-2里程表软轴(军绿)	Speed ometer cable	1
	6				
	7				
	8				
	9				
	10				
	11				
	12				
	13				
	14				
	15				
	16				
	17				
	18				
	19				
	20				

www.seacubemoto.com

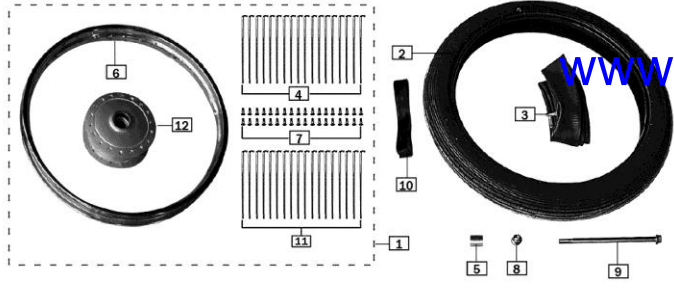
前条轮 FRONT WHEEL		Revision Number Page:10			
	NO.	PART CODE	CHINESE DESCRIPTION	ENGLISH DESCRIPTION	QTY
	1	51110-J170-0100	ZS150-6(IV)前条轮(1.6x18)	Front wheel (1.4x18)	1
	2	51103-J110-0000	ZS150-15前轮外胎(3.00x18)花纹P03	F.wheel outer tyre 2.75x18	1
	3	51104-J110-0000	ZS150-15前轮内胎	Inner tyre	1
	4	51113-2040-1605	前条轮外辐条(Φ4.0x160.5)(125-2Z前)	Spoke Φ4.0×160.5	18
	5	51102-1126-00000C	ZS125-2前轮右衬套(Φ12xΦ23x25)	Right bush,Front wheel	1
	6	51112-0000-17000G	条轮轮圈(1.6x18)(S)	Rim 1.6x18	1
	7	51124-0000-03000C	辐条螺母(M4.0x0.7、彩锌)	Nut M4.0x0.7,spoke	36
	8	B06187(1212000060C)	螺母M12x1.25	Nut M12x1.25	1
	9	51181-1126-00000C	ZS125-2前轮轴(M12x1.25x203、彩锌)	Front wheel axle m12x1.25x201	1
	10	51205-0000-0000	条轮垫带	Pad belt	1
	11	51113-1040-1615	前条轮内辐条(Φ4.0x161.5)(125-2Z前)	Spoke Φ4.0×161.5	18
	12	51115-0000-150071	前条轮轮毂总成(125-2Z前环形筋、银白)(S)	Front hub,spoke wheel	1
	13				
	14				
	15				
	16				
	17				
	18				
	19				
	20				

消声器/化油器MUFFLER/CARBURETOR

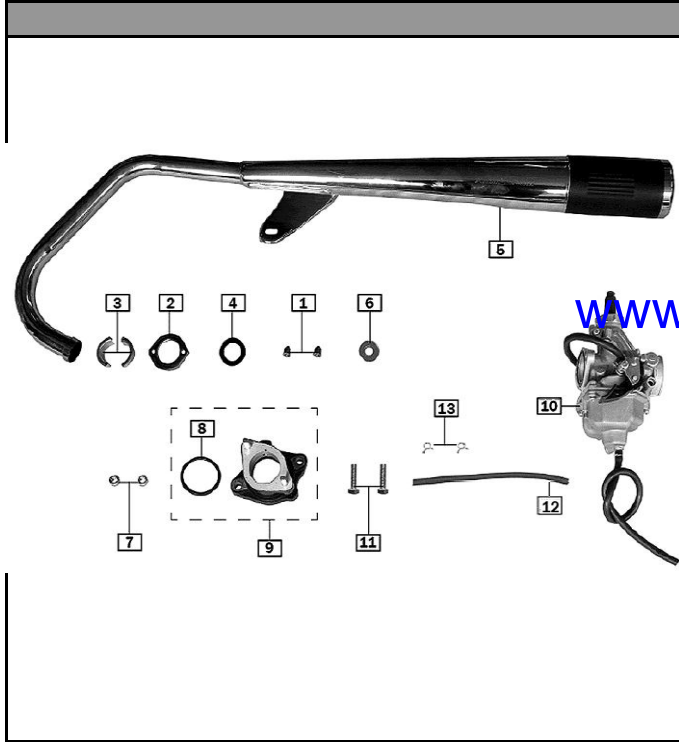

			Revision Number Page:11	
NO.	PART CODE	CHINESE DESCRIPTION	ENGLISH DESCRIPTION	QTY
1	91202-1060-01730G	盖形长螺母M6×17(镀铬5级)	Cap nut M6x17	2
2	18005-1126-02000G	ZS125-2排气消声器法兰盘(Φ10×58)	Flange ring	1
3	18003-1126-36000C	ZS125-2(H02)排气消声器连接块(彩锌)	Connecting block	2
4	18030-1357-0000	ZS125-2S(GH02)排气消声器密封垫(镀铜)	Seal pad,ex muffler	1
5	18000-J170-06000G	ZS150-6 (H06) 排气消声器(改挂板/ZONGSHEN/法兰盘M8/镀铬)	Ex muffler	1
6	91301-0120-24040C	平垫圈Φ12×Φ24×4	Washer Φ12xΦ24x4	1
7	B061770106000060C	螺母 M6	Nut m6	2
8	90101-31325000300	O形密封圈 32.5×3	O-ring 32.5x3	1
9	15800-1126-0300	ZS125-2进气管(环保、带负压管)	Intake pipe	1
10	17100-J150-1400	ZS150C化油器(单油门,耐油)	Carburetor	1
11	B057830006002070C	螺栓M6×20	Bolt M6x20	2
12	61302-0000-0900	复合油管(φ4×φ8×220、耐油)	Fuel hose (Φ4xΦ8x220)	1
13	91402-0075-07510C	卡簧φ7.5(彩锌)	Clip Φ7.5	2
14				
15				
16				
17				
18				
19				
20				

空滤器 AIR CLEANER		Revision Number Page:12			
	NO.	PART CODE	CHINESE DESCRIPTION	ENGLISH DESCRIPTION	QTY
	1	16116-I126-0300	空滤器外壳	Outer case,air cleaner	1
	2	1611A-I126-0300	空滤器滤芯组件	Filter element	1
	3	6222A-0000-3500	工字型胶垫(φ8.5×φ11×φ16.5-2.25+3+2.25,天然胶)	rubber bush (φ 8.5× φ 11× φ 16.5-2.25+3+2.25)	1
	4	16105-I126-C000	空滤器盖	Cover,air cleaner	1
	5	16114-I126-C000	空滤器滤网	Filter screen	1
	6	B0084500048013X0C	自攻螺钉ST4.8×13	Screw st4.8×13	5
	7	16123-I126-0300	空滤器接头卡箍	Clip,air cleaner joint	1
	8	61202-1060-35060C	翻边垫16×φ25×1.5-5.5(彩锌)	Washer φ6×φ25×1.5-5.5	1
	9	61180-0000-0300	燃油过滤器(一体式、耐油)	Fuel filter	1
	10	16100-I126-C000	ZS125-2(I)空滤器(环保、无中文字样)	Air cleaner	1
	11	B057830006002070C	螺栓M6×20	Bolt M6×20	1
	12				
	13				
	14				
	15				
	16				
	17				
	18				
	19				
	20				

前制动器FRONT BRAKE		Revision Number Page:13			
	NO.	PART CODE	CHINESE DESCRIPTION	ENGLISH DESCRIPTION	QTY
	1	54140-J170-0300	前制动器盖	Cover,front brake	1
	2	54112-J170-0300	前制动凸轮	Cam,front brake	1
	3	54107-J170-0300	前制动器复位弹簧	Return spring,front brake	1
	4	54131-J170-0300	前制动器计速齿轮	Count gear,front brake	1
	5	54121-J170-0300	前制动器指示片	Indicator,front brake	1
	6	54115-J170-0300	前制动器拉臂	Pull arm,front brake	1
	7	54104-J170-0300	前制动器拉簧	Spring,front brake	2
	8	54150-J170-0300	前制动器蹄块组件	Front brake shoes	2
	9	54162-J170-0300	前制动器异型螺母	Nut	1
	10	B008200005001650C	十字半沉头螺钉M5×16	Screw m5x16	1
	11	B057820006003070C	螺栓M6×30	Bolt m6x30	1
	12	54100-J170-030071	ZS150-6(V)前制动器(无石棉/压断力≥28KN、银白)	Front brake	1
13					
14					
15					
16					
17					
18					
19					
20					

全车锁VEHICLE LOCK				Revision Number Page:14	
	NO.	PART CODE	CHINESE DESCRIPTION	ENGLISH DESCRIPTION	QTY
	1	07002-I126-C700	ZS125-2全车锁(精品、四锁、双面ZONGSHEN)	Vehicle lock	1
	2	63704-I126-0200	ZS125-2(I)点火开关罩	Ignition switch cover	1
	3	B166740108001670G	GB/T16674.1螺栓M8×16(镀铬8.8级)	Bolt M8×16	2
	4	B0007001050020Z00	GB/T70.1内六角螺钉M5×20(不锈钢)	Screw M5×20	3
	5	B0007001050012Z00	GB/T70.1内六角螺钉M5×12(不锈钢)	Washer M5×12	5
	6	61110-I126-C700	油箱盖锁	lock,fuel tank cap	1
	7	08310-I126-0000	钥匙	keys	2
	8	83320-I126-0000	侧盖锁	lock,side cap	2
	9	6332M-I126-0000	侧盖锁卡片	lock clip,side cap	2
	10	84200-I126-0000	点火开关锁	ignition key	1
	11				
	12				
	13				
	14				
	15				
	16				
	17				
	18				
	19				
	20				

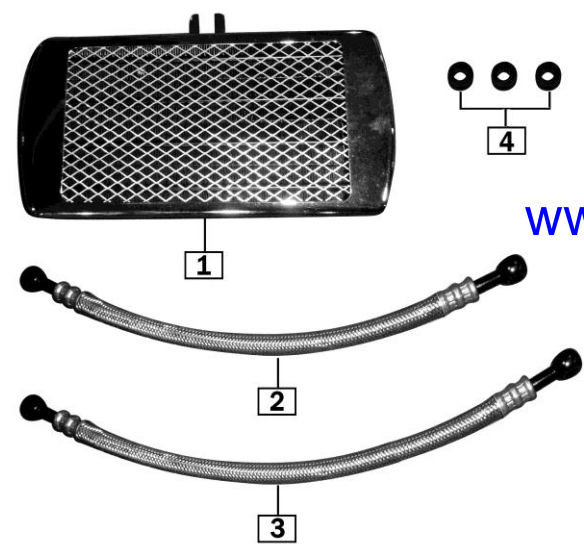
油冷器					Revision Number Page:15
	NO.	PART CODE	CHINESE DESCRIPTION	ENGLISH DESCRIPTION	QTY
 <p>1</p> <p>2</p> <p>3</p> <p>4</p> <p>www.seacubemoto.com</p>	1	19300-I126-C300	ZS125-2油冷器(支架2mm, 圆孔软连接, 平面接头)	Oil cooler	1
	2	19301-I126-C000	ZS125-2油冷器油管(平面接头, 带附件, 345mm)	Pipe,oil cooler	1
	3	19301-I126-C100	ZS125-2油冷器油管(平面接头, 带附件, 365mm)	Pipe,oil cooler	1
	4	93111-M567-0000	ZS250GS圆形胶圈	rubber bush	3
	5				
	6				
	7				
	8				
	9				
	10				
	11				
	12				
	13				
	14				
	15				
	16				
	17				
	18				
	19				
	20				

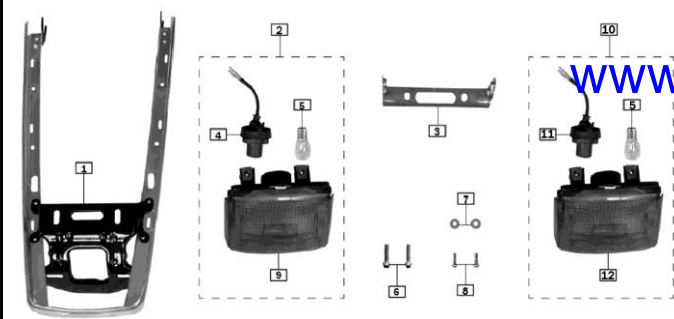
尾灯TAIL LAMP		Revision Number Page:16			
	NO.	PART CODE	CHINESE DESCRIPTION	ENGLISH DESCRIPTION	QTY
	1	62400-1126-0000	ZS125-2护框组件	Casing	1
	2	86200-1126-0800	ZS125-2(1)尾灯总成(三统一水晶灯ZS字)	Tail lamp assembly	1
	3	86203-1126-000065	ZS125-2尾灯支架(0610-114)	Bracket, rear lamp	1
	4	86202-1126-0800	尾灯线束	Cable,tail lamp	1
	5	86260-0000-C100	尾灯灯泡12V21/5W	Bulb 12v21/5w	2
	6	B166740108002570C	螺栓 M8×25	Bolt m8x25	2
	7	B0009601060000K0C	大平垫 6	Washer 6	2
	8	B057831006001670C	螺栓 M6×16	Bolt m6x16	2
	9	86204-1126-0800	尾灯灯罩	Lens	1
	10	86200-1126-C400	ZS125-2尾灯总成(线长150MM、蓝色、1007-134)	Tail lamp assembly	1
	11	86202-1126-C400	尾灯线束	Cable,tail lamp	1
	12	86204-1126-C400	尾灯灯罩	Lens	1
	13				
	14				
	15				
	16				
	17				
	18				
	19				
	20				

侧盖SIDE COVER		Revision Number Page:17		
NO.	PART CODE	CHINESE DESCRIPTION	ENGLISH DESCRIPTION	QTY
1	63601-1126-C10043	ZS125-2(I)尾罩(圆管货架、浅紫深蓝)	Rear shield(light purple dark blue)	1
1	63601-1126-C10011	ZS125-2(I)尾罩(圆管货架、透明红)	Rear shield(red)	1
1	63601-1126-C10031	ZS125-2(I)尾罩(圆管货架、油绿)	Rear shield(green)	1
1	63601-1126-C100Y2	ZS125-2(I)尾罩(圆管货架、老挝灰)	Rear shield(grey)	1
1	63601-1126-C10065	ZS125-2(I)尾罩(圆管货架、珍珠黑)	Rear shield(pearl black)	1
2	63332-1126-C0D3A5	ZS125-2右侧盖(透明红+亚黑、D3#)	Right side cover(red+Frosted black,D3#)	1
2	63332-1126-C0D3V9	ZS125-2右侧盖(油绿+亚黑、D3#)	Right side cover(green+Frosted black,D3#)	1
2	63332-1126-C0D42R	ZS125-2右侧盖(老挝灰+亚黑、D4#)	Right side cover(grey+Frosted black,D4#)	1
2	63332-1126-C0D4D6	ZS125-2右侧盖(浅紫深蓝+亚黑、D4#)	Right side cover(light purple dark blue+Frosted black,D4#)	1
2	63332-1126-C0D4A2	ZS125-2右侧盖(珍珠黑+亚黑、D4#)	Right side cover(pearl black+Frosted black,D4#)	1
3	63301-1126-C0D3A5	ZS125-2左侧盖(透明红+亚黑、D3#)	Left side cover(red+Frosted black,D3#)	1
3	63301-1126-C0D3V9	ZS125-2左侧盖(油绿+亚黑、D3#)	Left side cover(green+Frosted black,D3#)	1
3	63301-1126-C0D42R	ZS125-2左侧盖(老挝灰+亚黑、D4#)	Left side cover(grey+Frosted black,D4#)	1
3	63301-1126-C0D4D6	ZS125-2左侧盖(浅紫深蓝+亚黑、D4#)	Left side cover(light purple dark blue+Frosted black,D4#)	1
3	63301-1126-C0D4A2	ZS125-2左侧盖(珍珠黑+亚黑、D4#)	Left side cover(pearl black+Frosted black,D4#)	1
4	31233-1126-01000C	ZS125-2(I)右侧盖锁座(彩锌)	Lock holder, right side cover	1
5	B166740106001270C	螺栓M6x12	Bolt m6x12	4
6	9A133-1042-016X0C	自攻螺钉ST4.2x16	Screw st4.2x16	6
7	31232-1126-01000C	ZS125-2(I)左侧盖锁座(彩锌)	Lock holder	1
8	63346-1126-0400	ZS125-2(I)侧盖胶圈(三元乙丙橡胶)	Rubber washer	5

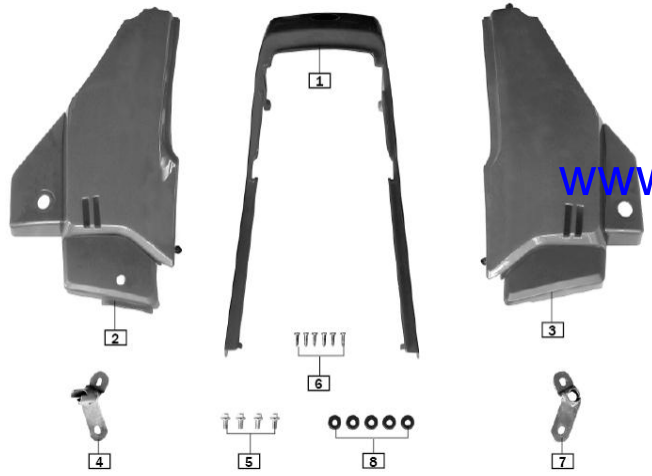

电气元件ELECTRIC PARTS		Revision Number Page:18			
	NO.	PART CODE	CHINESE DESCRIPTION	ENGLISH DESCRIPTION	QTY
	1	85100-I126-C800	ZS125-2主电缆(无防盗)	Main cable	1
	2	85520-I126-00000G	ZS125-2高音喇叭(红芯)	Horn	2
	3	B057830006001070C	GB/T5783螺栓M6×10(彩锌8.8级)	Bolt m6×10	2
	4	81100-I126-C000	ZS125-2点火线圈(出口、带火花塞帽)	Ignition loop	1
	5	B057830005001670C	螺栓M5×16	Bolt m5×16	2
	6	82290-I126-0500	ZS125-2启动继电器	Starting relay	1
	7	85600-H259-C000	ZS110-60闪光器(东协版、泰国菜蓝状态)	Flisher	1
	8	85171-0100-0100	保险管 15A	Fuse 15A	2
	9	83100-I265-C000	LZX125-2调压整流器(全波、开关式、63V)	Rectifier	1
	10	81200-I126-0000	ZS125-2点火器	Ignition	1
	11	08216-0000-0000	扎带L=130mm	Band l=130mm	4
	12	84600-I126-0000	后制动灯开关	Switch,rear brake light	1
	13	83200-C000-0300	蓄电池(12N7-3B、干荷式、出口)	Battery(12n7-3b)	1
	14	81110-I126-C000	ZS125-2干扰抑制器	Sippresser	1
	15	85111-0000-0000	整车搭铁线(G4,300mm)	Wire	1
	16	83230-0000-0900	电解液(12N7-3B)	Electrolyte (12n7-3b)	1
	17	85530-I126-00000G	ZS125-2低音喇叭(红芯)	Horn	1
	18	B166740106002070C	螺栓M6×20	Bolt M6×20	2
	19	85170-0000-0000	保险盒	Fuse case	1
	20	B166740106001270C	螺栓M6×12	Bolt M6×12	1
	21	17191-I126-00000C	ZS125-2高压线勾(彩锌)	High voltage wire hook	1
	22	85107-I126-0000	ZS125-2主电缆线勾(S)	Hook, main cable	1

后条轮REAR WHEEL		Revision Number Page:19		
NO.	PART CODE	CHINESE DESCRIPTION	ENGLISH DESCRIPTION	QTY
1	51210-J170-0000	ZS150-6后条轮(1.85x18)	Rear wheel(1.85x18)	1
2	51124-0000-03000C	辐条螺母(M4.0x0.7、彩锌)	Nut M4.0x0.7,spoke	36
3	51203-G134-0000	ZS100-19后轮外胎(3.00x18)	Outer tyre(3.00x18)	1
4	51204-G134-0000	ZS100-19后轮内胎	Inner tyre	1
5	B061870214000060C	后轮轴螺母M14x1.5	Nut M14x1.5	1
6	51114-3040-1595	后条轮外辐条(Φ4.0x159.5)(150-6Ⅶ后)	Spoke φ 4.0x159.5	18
7	51201-I126-00000C	ZS125-2后轮左衬套(φ 15.1x φ 27.8x17,彩锌)	Rear wheel left sleeve	1
8	51214-0100-040071	后条轮轮毂总成(加厚125后、银白)(S)	Rear hub,spoke wheel	1
9	51205-0000-0000	条轮垫带	Pad belt	1
10	51202-I126-00000C	ZS125-2(H02)后轮右衬套(φ 15x φ 28)	Right bush,rear wheel(φ 15x φ 28)	1
11	51281-I126-03000C	ZS125-2(H02)后轮轴(M14x1.5x285)	Rear wheel shaft M14x1.5x285	1
11	51281-I126-04000C	ZS125-2后轮轴(M14x1.5x234、轴Φ15)(彩锌)	Rear wheel shaft M14x1.5x234	1
12	35010-I126-02000C	ZS125-2(H02)链条调节器	Chain adjustor	2
13	35020-I126-0000	链条调节器卡块	Block,chain adjuster	2
14	51112-0000-18000G	条轮轮圈(1.85x18)(S)	Rear rim(1.85x18)	1
15	51114-3040-1605	后条轮内辐条(Φ4.0x160.5、加高)	Spoke φ 4.0x160.5	18
16	51217-0000-0000	后轮缓冲套(φ24)	Buffer bush	4
17				
18				
19				
20				

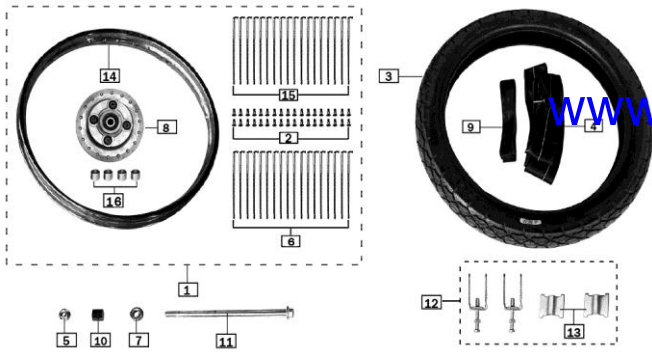

车架FRAME				Revision Number Page:20	
	NO.	PART CODE	CHINESE DESCRIPTION	ENGLISH DESCRIPTION	QTY
	1	31100-I126-C0006N	ZS125-2车架(加强油冷、带二次补气阀支架、粉亮黑)	Frame	1
	2	32303-I126-000065	ZS125-2发动机前悬挂(珍珠黑)	Front suspension	1
	3	32301-I126-000065	ZS125-2发动机左上连接板(珍珠黑)	Upper connecting plate	2
	4	B061700008000060C	GB/T6170螺母M8(彩锌8级)	Nut m8	7
	5	B166740108009070C	GB/T16674.1螺栓M8x90(彩锌8.8级)	Bolt M8x90	2
	6	B166740108007070C	GB/T16674.1螺栓M8x70(彩锌8.8级)	Bolt M8x70	3
	7	B061870210000060C	锁紧螺母M10x1.25	Nut M10x1.25	2
	8	B1667401310011570C	GB/T16674.2螺栓M10x1.25x115(彩锌8.8级)	Bolt M10x1.25x115	2
	9	08216-0000-0200	扎带L=220mm	Band L=220mm	4
	10	08216-0000-0400	扎带L=300mm	Band L=300mm	4
	11	31102-G124-0000	ZS100车架胶管(φ8)	Rubber tube,frame	7
	12	31201-0000-C400	车架铭牌(英文、ZONGSHEN、通用、纯铝)	Nameplate,frame	1
	13	31263-0000-0000	铭牌铆钉(2120)	Rivet,nameplate	2
	14	71113-I126-000065	ZS125-2喇叭支架	Bracket,horn	1
	15	B166740108007570C	GB/T16674.1螺栓M8x75(彩锌8.8级)	Bolt M8x75	1
	16	B166740108002070C	GB/T16674.1螺栓M8x20(彩锌8.8级)	Bolt M8x20	4
	17				
	18				
	19				
	20				

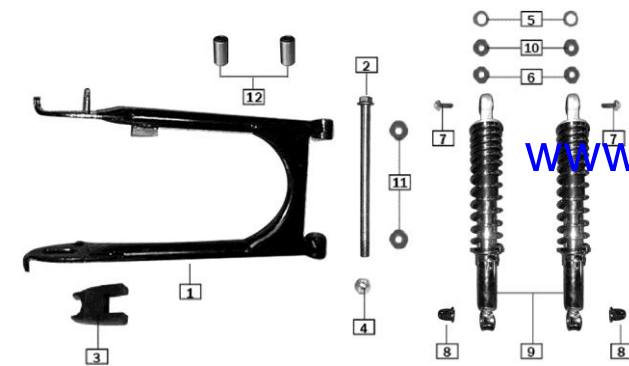
平叉/后减震器REARFORK/REARSHOCKABSORBER		Revision Number Page:21			
	NO.	PART CODE	CHINESE DESCRIPTION	ENGLISH DESCRIPTION	QTY
	1	35200-1126-C7006N	ZS125-2平叉总成(秘鲁三轮车,左,无后脚蹬,加长,粉亮黑)	Rear fork	1
	2	35281-1126-08000C	ZS125-2平叉轴(M12x1.25x254、彩锌)	Shaft rear fork (M12x1.25x254)	1
	3	35001-1126-0300	ZS125-2(I)链条护卡	Chain clip	1
	4	B061870212000060C	螺母M12x1.25	Nut m12x1.25	1
	5	91301-0120-24040C	平垫Φ12xΦ24x4(彩锌)	Washer Φ 12x Φ 24x4	2
	6	91301-0080-24030G	平垫Φ8xΦ24x3(镀铬)	Washer Φ 8x Φ 24x3	2
	7	B057830008002070C	GB/T5783螺栓M8x20(彩锌8.8级)	Bolt m8x20	2
	8	91202-1080-01830G	盖形长螺母M8x17.5(镀铬6级)	Cap nut M8x17.5	2
	9	33300-J170-C0000G	ZS150-6后减震器(AG100、上下衬套为12mm、镀铬)	Rear shock absorber	2
	10	B0009701080000K0C	GB/T97.1平垫Φ8(彩锌140HV)	Washer Φ 8	2
	11	B0009701120000K0C	GB/T97.1平垫Φ12(彩锌140HV)	Washer Φ 12	2
	12	3520B-1126-0000	ZS125-2缓冲套组合(Φ 12.5xΦ 25x34)(S)	Buffer bush (Φ 12.5xΦ 25x34)	2
	13				
	14				
	15				
	16				
	17				
	18				
	19				
	20				

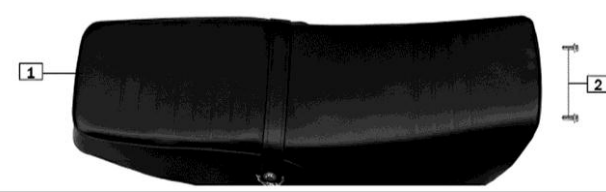
坐垫/后货架SEAT/REAR CARRIER		Revision Number Page:22			
	NO.	PART CODE	CHINESE DESCRIPTION	ENGLISH DESCRIPTION	QTY
	1	41100-I126-C170	ZS125-2双人座垫(宗塑、白底板、白板)	Seat	1
	2	B166740108001670G	GB/T16674.1螺栓M8×16(镀锌8.8级)	Bolt M8×16	2
	3				
	4				
	5				
	6				
	7				
	8				
	9				
	10				
	11				
	12				
	13				
	14				
	15				
	16				
	17				
	18				
	19				
	20				

www.seacubemoto.com

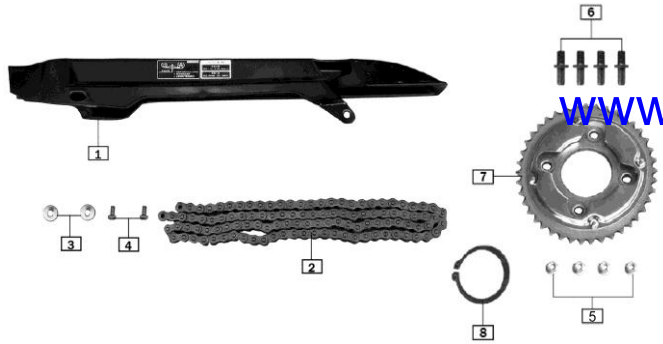
链盒CHAIN BOX					Revision Number Page:23
	NO.	PART CODE	CHINESE DESCRIPTION	ENGLISH DESCRIPTION	QTY
	1	35110-1126-0300	ZS125-2^(I)半链盒	Chain box	1
	2	26400-428H-0142	链条(428Hx142节)	Chain 428Hx142	1
	3	91302-0060-18040G	翻边垫圈φ6×18×4-1	Washer φ 6x18x4-1	2
	4	B057890006001270G	螺栓M6×12	Bolt M6x12	2
	5	B061770210000060C	GB/T6177.2螺母M10×1.25(彩锌8级)	Nut m10x1.25	4
	6	91118-6100-03700C	链轮螺栓M10×1.25×37.5(总长)	Bolt m10x1.25x37.5,sprocket	4
	7	55002-1126-09000C	ZS125-2链轮(带护罩,50齿,50T5890/428,彩锌)	Sprocket	1
	8	B0089401158000000S	轴用卡圈58	Check ring 58	1
	9				
	10				
	11				
	12				
	13				
	14				
	15				
	16				
	17				
	18				
	19				
	20				

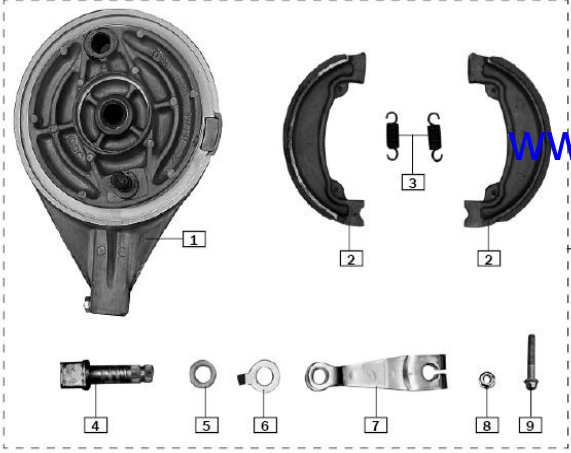
后制动器REAR BRAKE		Revision Number Page:24			
	NO.	PART CODE	CHINESE DESCRIPTION	ENGLISH DESCRIPTION	QTY
	1	54205-I126-C70071	后制动器盖	Cover,rear brake	1
	2	54150-I126-C700	前制动器蹄片组件	Shoes,front brake	2
	3	54104-I126-C700	前制动器拉簧	Pull spring,front brake	2
	4	54209-I126-C700	后制动器凸轮	Cam,rear brake	1
	5	54210-I126-C700	后制动器密封件	Seal parts,rear brake	1
	6	54208-I126-C700	后制动器指示片	Indicator,rear brake	1
	7	54207-I126-C700	后制动器拉臂	Pull arm,rear brake	1
	8	B0617701106000060C	螺母M6	Nut m6	1
	9	B057820006003570C	螺栓M6×35	Bolt m6x35	1
	10	54200-I126-C70071	ZS125-2后制动器(无石棉/条轮/银白)	Rear brake	1
	11				
	12				
	13				
	14				
	15				
	16				
	17				
	18				
	19				
	20				

工具/电池盒支架TOOL/BATTERY BRACKET		Revision Number Page:25			
	NO.	PART CODE	CHINESE DESCRIPTION	ENGLISH DESCRIPTION	QTY
	1	63710-1126-0200	ZS125-2(I)工具盒	Tool box	1
	2	83220-1126-030065	ZS125-2(I)蓄电池支架(电启动珍珠黑)	Bracket,battery	1
	3	83210-1126-0300	ZS125-2(I)蓄电池箍带(三元乙丙橡胶)	Band,battery	1
	4	06000-1265-C000	LZX125-2随车工具(六件套、白板)	Vehicle tools	1
	5	06002-0000-0000	鲤鱼钳	Pliers	1
	6	B166740106001270C	螺栓M6×12	Bolt m6×12	5
	7	06020-0000-C000	工具袋(白板)	tool bag	1
	8	06010-0100-0000	螺丝刀柄	screw handle	1
	9	06006-1126-0810	双头呆扳手8×10	double ends wrench 8×10	1
	10	06006-1126-1315	双头呆扳手13×15	double ends wrench 13×15	1
	11	06005-0000-0000	双头螺丝刀(S)	double ends screw	1
	12	06003-0000-0000	火花塞套筒(S)	socket,spark plug	1
	13				
	14				
	15				
	16				
	17				
	18				
	19				
	20				

前脚蹬/支架 FRONT REST/STAND

	NO.	PART CODE	CHINESE DESCRIPTION	ENGLISH DESCRIPTION	QTY	
	1	B057830008002070C	螺栓M8×20	Bolt m8×20	4	
	2	B0009701080000K0C	GB/T97.1平垫φ8(彩锌140HV)	Washer 8	4	
	3	B0009300080000K0C	GB/T93弹圈φ8(彩锌)	Elastic washer 8	4	
	4	B000910003002500C	开口销3×25	Split pin 3×25	1	
	5	91301-0170-23020C	平垫圈φ17×φ23×1.5	Washer φ 17× φ 23×1.5	1	
	6	32204-1126-0100	ZS125-2主支架减震垫(精品车)	Absorber pad,main stand	1	
	7	32281-1126-00000C	ZS125-2主支架轴(彩锌)	Shaft,main stand	1	
	8	32140-1126-000065	ZS125-2主梁杆(珍珠黑)	Rod,crossbeam	1	
	9	32101-1126-0000	ZS125-2前脚蹬胶套	Rubber sheath,front footrest	2	
	10					
	11					
	12					
	13					
	14					
	15					
	16					
	17					
	18					
	19					
	20					

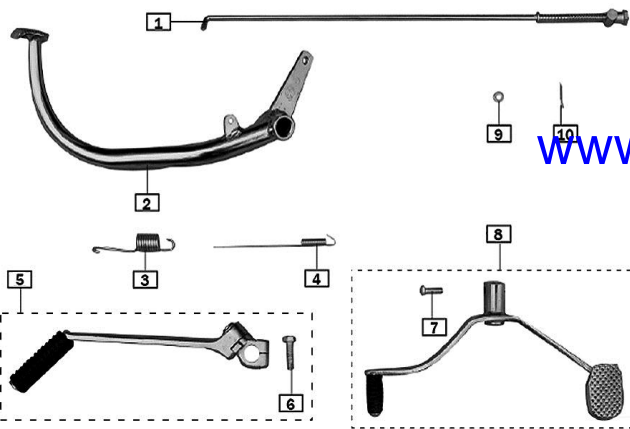
脚踏操纵件FOOT CONTROL PARTS		Revision Number Page:27			
	NO.	PART CODE	CHINESE DESCRIPTION	ENGLISH DESCRIPTION	QTY
	1	52200-1126-00000C	ZS125-2后制动臂拉杆(彩锌)	Rear brake pull lever	1
	2	52100-1126-05000G	ZS125-2^(I)后制动臂(加油槽)	Rear brake lever	1
	3	52201-1126-00000C	ZS125-2^(I)后制动臂回位簧(彩锌)	Return spring,rear brake lever	1
	4	84602-1126-00000C	ZS125-2后制动灯开关簧(彩锌)	Switch spring,rear brake light	1
	5	21200-1126-04000G	ZS125-2(I)启动臂(三统一、镀铬)	Assembly,starting lever	1
	6	B05783000800227	螺栓M8×22	Bolt m8x22	1
	7	B05783000600207	螺栓M6×20	Bolt m6x20	1
	8	24400-1126-05000G	ZS125-2^(I)变速踏板(镀铬)	Gear shift lever	1
	9	B0009701060000K0C	平垫圈6	Washer 6	1
	10	B000910002002000C	GB/T91开口销2×20(彩锌)	Split pin φ2x18	1
	11				
	12				
	13				
	14				
	15				
	16				
	17				
	18				
	19				
	20				

油箱FUEL TANK		Revision Number Page:28			
	NO.	PART CODE	CHINESE DESCRIPTION	ENGLISH DESCRIPTION	QTY
	1	87200-1126-0000	ZS125-2燃油传感器	Fuel sensor	1
	2	61150-1126-0400	ZS125-2(I)油开关(耐油、细)	Fuel shut-off	1
	3	B0009701060000K0C	平垫圈6	Washer 6	4
	4	B061770106000060C	螺母M6	Nut m6	4
	5	61100-1126-C4D311	ZS125-2油箱(赛车口,有标,14升,透明红,D3#)	Fuel tank(red,D3#)	1
	5	61100-1126-C4D331	ZS125-2油箱(赛车口,有标,14升,油绿,D3#)	Fuel tank(green,D3#)	1
	5	61100-1126-C4D4Y2	ZS125-2油箱(赛车口,有标,14升,老挝灰,D4#)	Fuel tank(grey,D4#)	1
	5	61100-1126-C4D442	ZS125-2油箱(赛车口,有标,14升,浅紫深蓝,D4#)	Fuel tank(light purple dark blue,D4#)	1
	5	61100-1126-C4D465	ZS125-2油箱(赛车口,有标,14升,珍珠黑,D4#)	Fuel tank(pearl black,D4#)	1
	6	B166740108003070C	螺栓M8x30	Bolt m8x30	1
	7	91302-0085-32110C	翻边垫 φ 8.5x φ 32-11(彩锌)	Flanged washer φ 8.5× φ 32-11	1
	8	61121-1126-0200	ZS125-2(I)油箱胶垫	Rubber pad	1
	9	61111-1126-0200	ZS125-2(I)油箱前缓冲套	Fuel tank front cushion	2
	10	61112-1126-0200	ZS125-2(I)油箱后缓冲套	Fuel tank rear cushion	1
	11	87201-1126-0000	传感器密封圈	Seal ring, sensor	1
	12	62143-0000-0400	单层油管 (φ 5× φ 9+ φ 7× φ 11 (700+	Pipe (φ 5× φ 9+ φ 7× φ 11(700+20))	1
	13	61314-0000-4100	油管总成 (φ 4× φ 8× 540、耐油、 φ	Pipe (φ 4× φ 8× 540)	1
	14	61302-0000-6800	复合油管(φ4×φ8×100,耐乙醇汽油,川环雅马哈状态)	Fuel hose (φ 4x φ 8x100)	1
	15	91402-0075-07510C	卡簧φ7.5(彩锌)	Clip φ 7.5	2
	16	35201-1552-0000	ZS125-30平叉防尘盖	Dustproof cap,fork	1
17					
18					
19					
20					

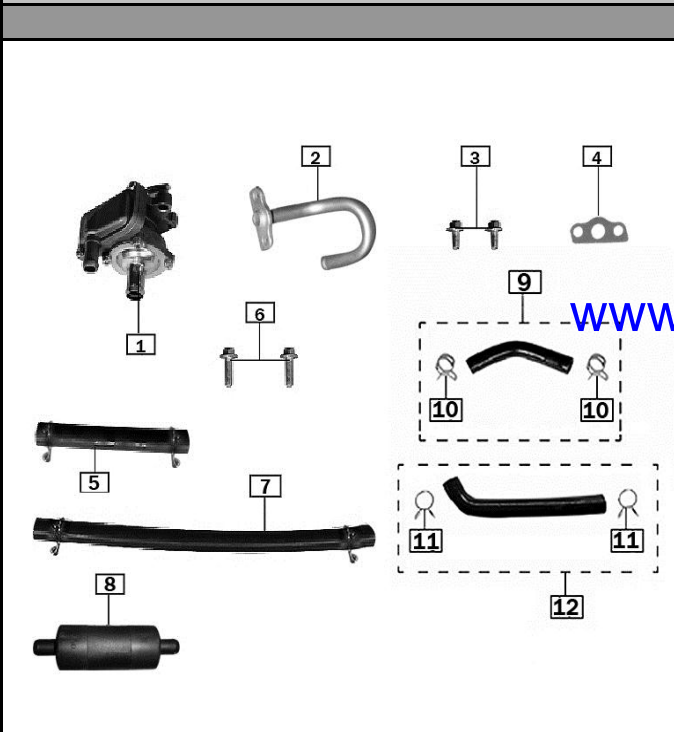
环保装置 ENVIRONMENT PROTECT MECHANISM				Revision Number Page:29	
	NO.	PART CODE	CHINESE DESCRIPTION	ENGLISH DESCRIPTION	QTY
	1	18090-I008-0201	CG125D-2#空气泵	Air pump	1
	2	1809B-J862-00000U	ZS150-6C(GH17国Ⅲ)废气循环铁管组合(达克罗)	Pipe	1
	3	B166740106001671C	GB/T16674.1螺栓M6×16(φ11,彩锌8.8级)	Bolt M6×16	2
	4	90268-0000-0100	废气循环铁管密封垫(CG133)	Gasket	1
	5	18098-0000-5400	二次补气进气胶管(φ10×φ15×110)	Pipe φ10×φ15×110	1
	6	B166740106002070C	螺栓M6×20	Bolt M6×20	2
	7	18098-0000-5300	二次补气阀连接管(φ11×φ16×390\两个夹箍)	Pipe (φ11×φ16×390)	1
	8	16160-0000-0100	CG125D-2#二次空滤器部件	Air cleaner	1
	9	18092-0000-6500	废气循环橡胶管(φ9×φ15×((30+65)+30)、彩锌片卡2件)	Pipeφ9×φ15×(50+60)mm	1
	10	18097-0000-01000C	废气循环胶管卡箍φ15	Circlipφ15	2
	11	16177-0000-01000C	二次胶管管箍φ15.5	Circlipφ15.5	2
	12	12105-I126-0000	ZS125-2(I)通气管φ10×φ16×(125+30)mm	Vent tube φ10×φ16×(125+30)mm	1
	13				
	14				
	15				
	16				
	17				
	18				
	19				
	20				

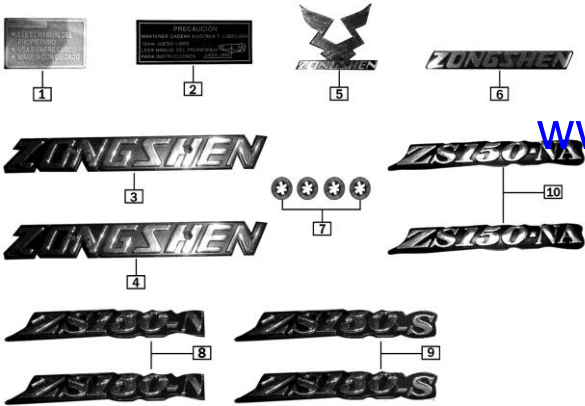
标牌Label		Revision Number Page:30				
	NO.	PART CODE	CHINESE DESCRIPTION	ENGLISH DESCRIPTION	QTY	
	1	01154-0000-C100	油箱警示标志(西班牙文, 秘鲁专用)	Warning label, oil tank	1	
	2	35111-0000-C200	驱动链条标志(西班牙文, 秘鲁专用)	Sign,driving chain	1	
	3	61105-I126-0000J	ZS125-2油箱左标牌(金黄)	Left label,fuel tank	1	
	4	61106-I126-0000J	ZS125-2油箱右标牌(金黄)	Right label,fuel tank	1	
	5	63502-M567-0000	ZS250GS灯壳标牌(铝牌)	Label,light shell	1	
	6	87129-I126-0000	ZS125-2仪表标牌(金色ZONGSHEN)	Label, meter	1	
	7	63304-I126-0000	ZS125-2标牌卡子	Clip,label	4	
	8	01151-J170-C8000J	ZS150-6侧盖标牌(ZS150-N字样、金黄)	Label,side cap	2	
	9	01151-J170-C2000J	ZS150-6侧盖标牌(ZS150-S字样、金黄)	Label,side cap	2	
	10	01151-J170-C4000J	ZS150-6侧盖标牌(ZS150-NA字样、金黄)	Label,side cap	2	
	11					
	12					
	13					
	14					
	15					
	16					
	17					
	18					
	19					
	20					

www.seacubemoto.com

贴花Decal					Revision Number Page:31
NO.	PART CODE	CHINESE DESCRIPTION	ENGLISH DESCRIPTION	QTY	
1	63032-I126-C0D3	ZS125-2油箱左贴花 (TH257-04-33, D3#)	Left decal D3#,oil tank	1	
1	63032-I126-C0D3	ZS125-2油箱左贴花 (TH257-04-33, D3#)	Left decal D3#,oil tank	1	
1	63032-I126-C0D4	ZS125-2油箱左贴花 (H257-04-33, D4#)	Left decal D4#,oil tank	1	
1	63032-I126-C0D4	ZS125-2油箱左贴花 (TH257-04-33, D4#)	Left decal D4#,oil tank	1	
1	63032-I126-C0D4	ZS125-2油箱左贴花 (TH257-04-33, D4#)	Left decal D4#,oil tank	1	
2	63035-I126-C0D3	ZS125-2油箱右贴花 (TH257-04-33, D3#)	Right decal D3#,oil tank	1	
2	63035-I126-C0D3	ZS125-2油箱右贴花 (TH257-04-33, D3#)	Right decal D3#,oil tank	1	
2	63035-I126-C0D4	ZS125-2油箱右贴花 (TH257-04-33, D4#)	Right decal D4#,oil tank	1	
2	63035-I126-C0D4	ZS125-2油箱右贴花 (TH257-04-33, D4#)	Right decal D4#,oil tank	1	
2	63035-I126-C0D4	ZS125-2油箱右贴花 (TH257-04-33, D4#)	Right decal D4#,oil tank	1	
2	63035-I126-C0D4	ZS125-2油箱右贴花 (TH257-04-33, D4#)	Right decal D4#,oil tank	1	
3	630F0-0000-0000	蓄电池标贴 (40×30, ZONGSHEN字样, 秘鲁专用)	Label, battery	1	
4	63307-I126-C000	ZS125-2左侧盖锁开启标志 (英文)	Open sign,left side cap lock	1	
5	63338-I126-C000	ZS125-2右侧盖锁开启标志 (英文)	Open sign,right side cap lock	1	
6					
7					
8					
9					
10					
11					
12					

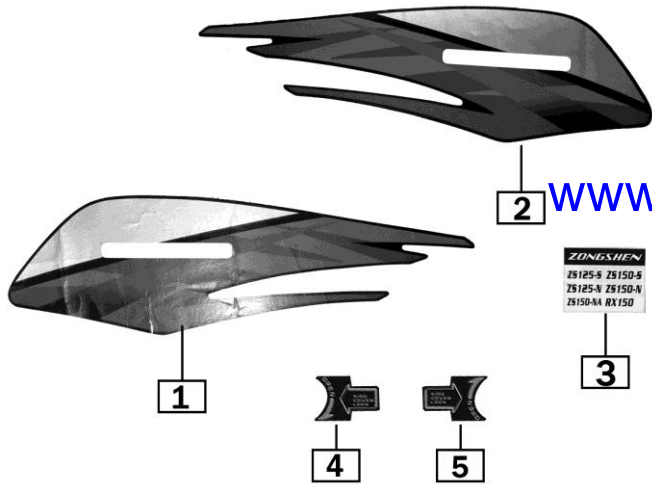



www.seacubemoto.com

三轮用零件Tricycle parts		Revision Number Page:32			
	NO.	PART CODE	CHINESE DESCRIPTION	ENGLISH DESCRIPTION	QTY
	1	54200-I126-C70071	ZS125-2后制动器(无石棉/条轮/银白)	Rear brake	1
	2	86200-I126-C300	ZS125-2尾灯总成(线长150MM 橙色 1007)	Rear lamp assembly	1
	3	35200-I126-C8006N	ZS125-2叉平叉总成(秘鲁三轮车 左右后脚踏加长)	Fork assembly	1
	4	55002-I126-10000C	ZS125-2链轮(含护罩、37齿)	Sprocket wheel	2
	5	26400-428H-0150	链条(428H×150节)	Chain(428H×150)	1
	6	3520B-I126-0000	ZS125-2缓冲套组合(Φ12.5×Φ25×34)(S)	Buffer bush (Φ12.5×Φ25×34)	2
	7				
	8				
	9				
	10				
	11				
	12				
	13				
	14				
	15				
	16				
	17				
	18				
	19				
	20				

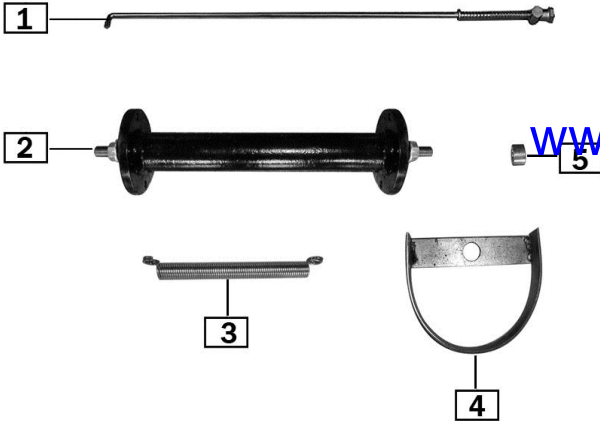
www.seacubemoto.com

三轮用零件2 Tricycle parts 2		Revision Number Page:33			
	NO.	PART CODE	CHINESE DESCRIPTION	ENGLISH DESCRIPTION	QTY
 <p>1: Rear brake pull rod 2: Transmission shaft 3: Rear brake returning spring 4: Chain block 5: Left bush, rear wheel</p>	1	71700-I126-C0000C	ZS125-2后制动拉杆(φ7×860、彩锌)	Rear brake pull rod	1
	2	3820B-I357-C0006N	ZS125-2S传动轴(带缓冲套及螺母、粉亮黑)	transmission shaft	1
	3	52105-I126-C0000C	ZS125-2后制动回位簧(φ2×158、彩锌)	Rear brake returning spring	1
	4	35316-I126-C0000C	ZS125-2链条挡块(挡圈、秘鲁专用, 彩锌)	Block,chain	1
	5	51201-I126-00000C	ZS125-2后轮左衬套(φ15.1×φ27.8×17, 彩锌)	Left bush, rear wheel	1
	6				
	7				
	8				
	9				
	10				
	11				
	12				
	13				
	14				
	15				
	16				
	17				
	18				
	19				
	20				

铝轮 aluminum wheel		Revision Number Page:34			
	NO.	PART CODE	CHINESE DESCRIPTION	ENGLISH DESCRIPTION	QTY
 <p>1</p>  <p>2</p>	1	51120-I126-180071	ZS125-2前铝轮(鼓, 1.6×18, 五星豪爵)	Front aluminum wheel	1
	2	51220-I126-060071	ZS125-2(X)后铝轮(五星豪爵、银白)	Rear aluminum wheel	1
	3				
	4				
	5				
	6				
	7				
	8				
	9				
	10				
	11				
	12				
	13				
	14				
	15				
	16				
	17				
	18				
	19				
	20				

www.seacubemoto.com